



Angel Elevators
& Escalators



Your Safety
Our Priority

{Lift your spirits with durable}
{comfortable & safe elevators}



OUR COMPANY

Angel Elevators and Escalators was initially Engal Lifts that saw a modest beginning in the year 2010. With very few maintenance contracts and no installation projects, the company is now maintaining about 150 elevators and has installed more than 100 elevators in Delhi and NCR region.

The company was promoted by Mr. **Manender Singh** who holds the **prestigious record of working with worlds best elevator company for more than 15 years**. Now it has a **team of highly qualified** and experienced personnel **including General Manager Sales and Operations having experience of more than 11 years and having international exposure**. The company was started with a vision to provide services that are better than most MNC companies working in India with cost effectiveness and without compromising on global safety procedures and standards.

We at Angel Elevators and Escalators are proud to give the **most valuable and robust products** to our customers by **offering free after-sales service for three years of product purchase** and after that customer can get the annual maintenance contract with us for smooth and effective performance for lifetime.



Angel Elevators
& Escalators

www.angelevators.in

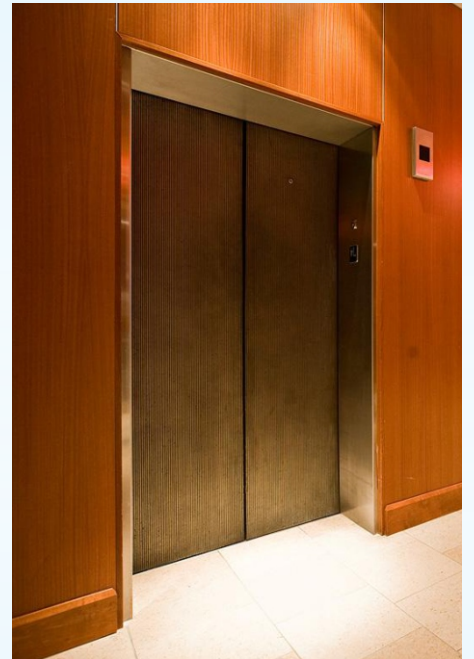
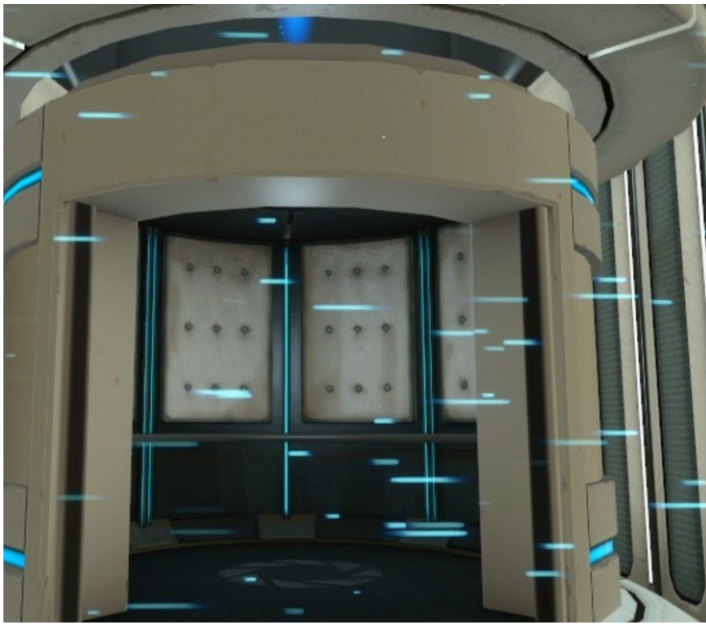

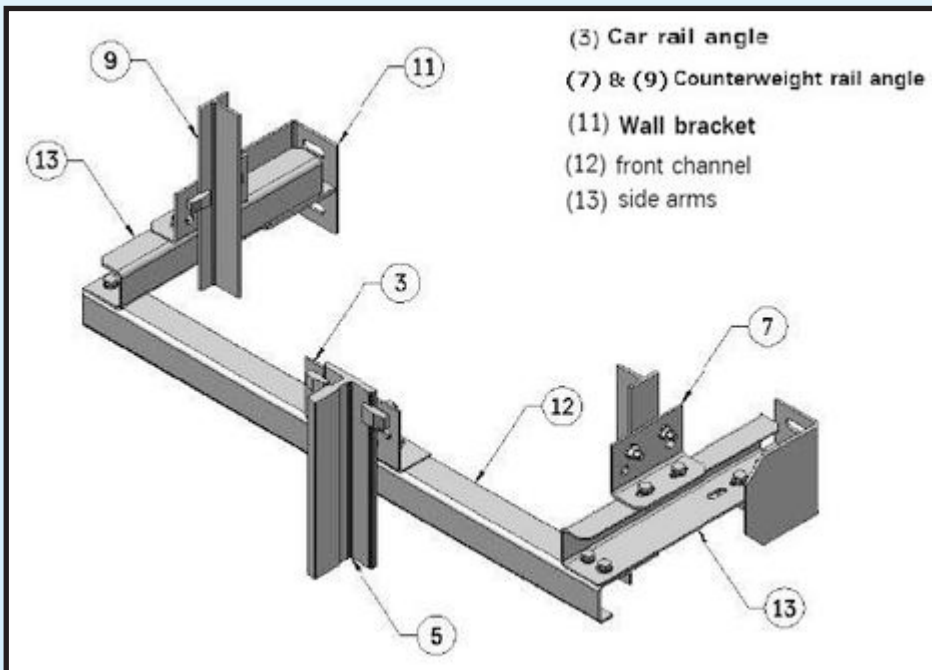
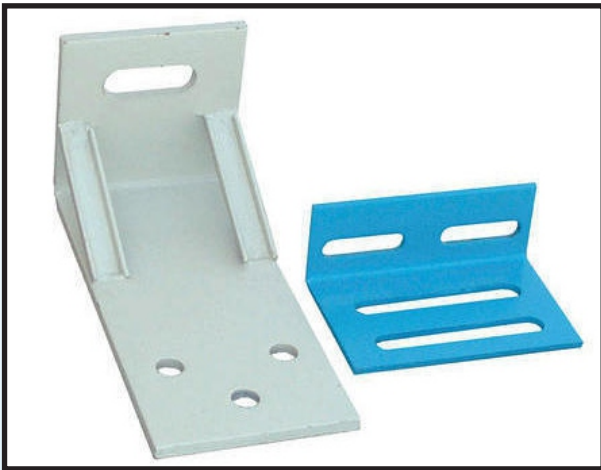

Angel Elevators
& Escalators

MICROPROCESSOR CONTROL SYSTEM

V3F ADVANTAGES

- Jerkless starting & stopping are achieved irrespective of load & precise leveling accuracy.
- Stopping of Elevator is done by perfect electrical breaking unit for minimizing the mechanical wear & tear, maintenance free performance forever.
- Due to smooth acceleration & deceleration, There is less wear & tear in mechanical parts.
- Higher starting torque helps in no motor overheating, high energy saving by lower starting current lower energy consumption & high power factor.
- Different Parameters like current, torques, speed, acceleration and deceleration time can be easily viewed, monitored and controlled on interactive panels.

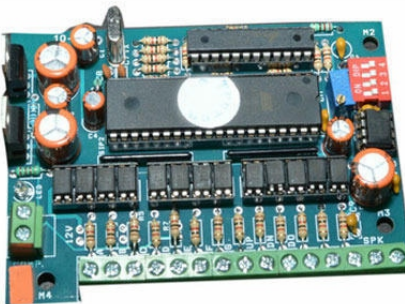
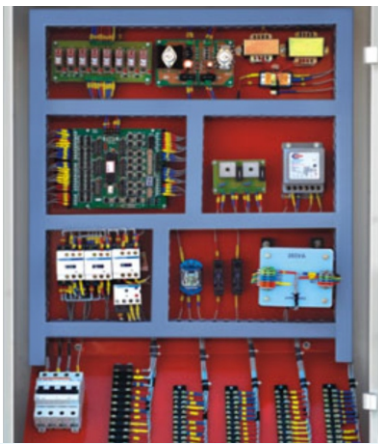

Cabin

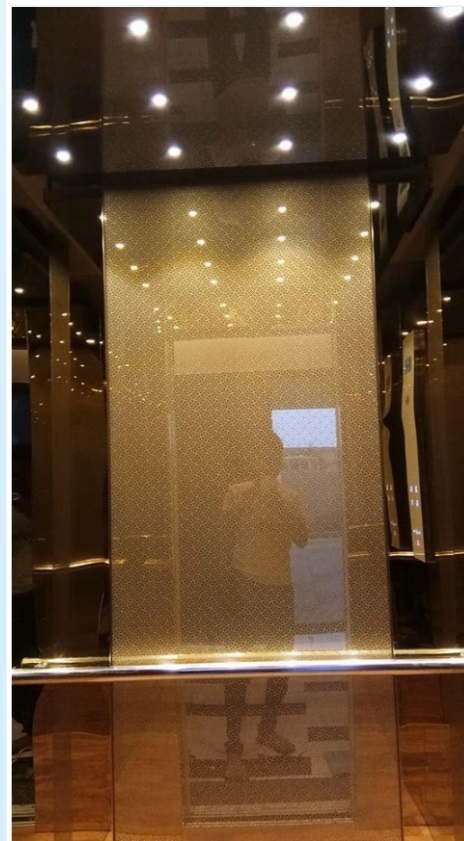

Doors





Angel Elevators
& Escalators

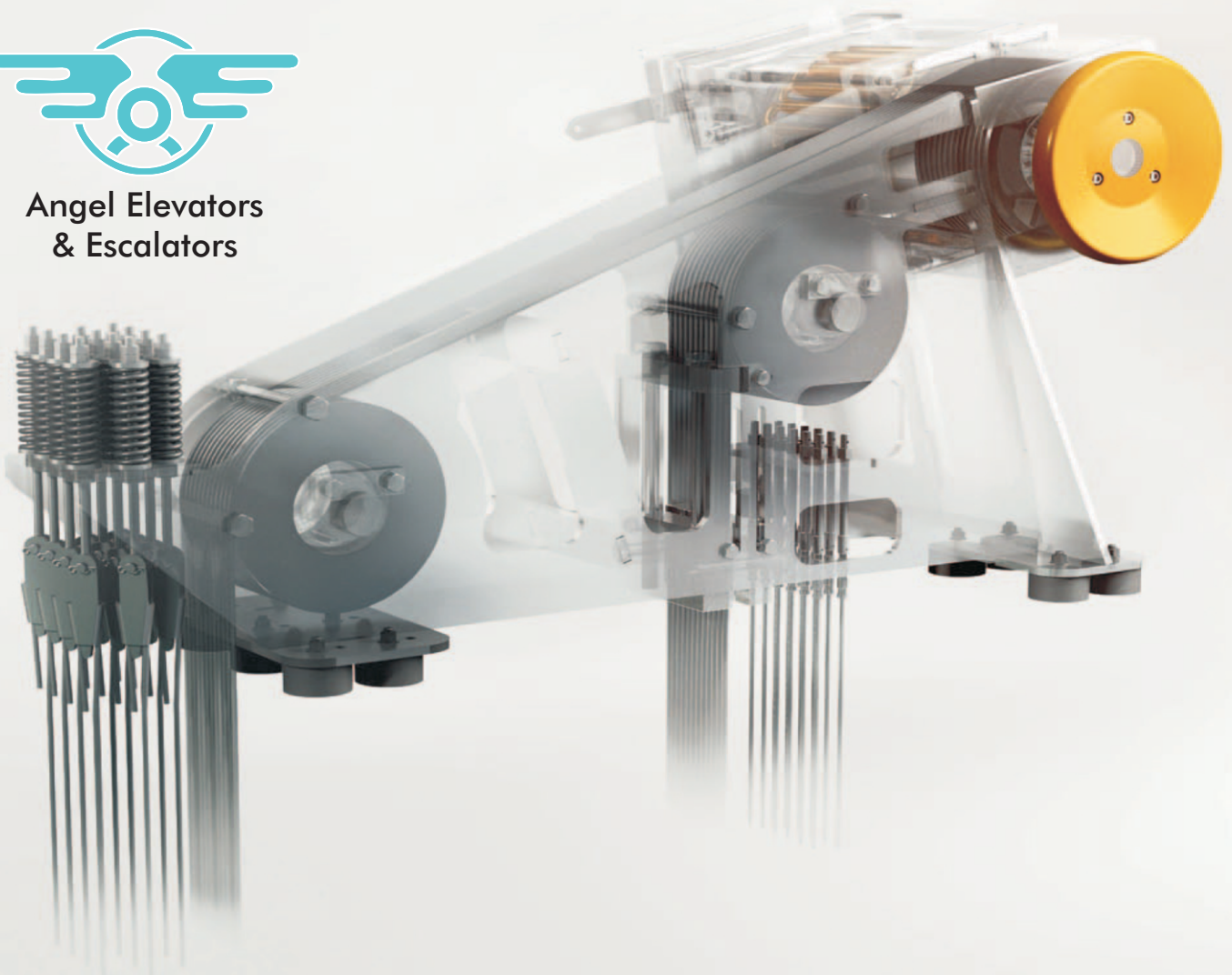



Angel Elevators
& Escalators





Angel Elevators & Escalators

The designer escalator
for stylish interiors.





Civil dimensions for Automatic passenger lift

Capacity		Car Inside		Lift Well		Entrance		Machine Room Size			Pit	Overhead
Pass.	Load in Kg.	Width	Depth	Width	Depth	Width	Height	Width	Depth	Height		
4	272	1100	700	1600	1250	700	2000	3100	3750	2500	1500	4250
5	340	1100	850	1600	1400	700	2000	3100	3900	2500	1500	4250
6	408	1100	1000	1600	1600	700	2000	3100	4100	2500	1500	4250
8	544	1300	1100	1800	1700	800	2000	3300	4200	2500	1500	4250
10	680	1350	1300	1900	1900	800	2000	3400	4400	2500	1500	4250
13	884	2000	1100	2500	1700	900	2000	4000	4200	2500	1500	4250
16	1088	2000	1300	2500	1900	1000	2000	4000	4400	2500	1500	4250
20	1360	2000	1500	2500	2100	1000	2000	4000	4600	2500	1500	4250

Civil dimensions for Manual passenger lift

Capacity		Car Inside		Lift Well		Entrance		Machine Room Size			Pit	Overhead
Pass.	Load in Kg.	Width	Depth	Width	Depth	Width	Height	Width	Depth	Height		
4	272	1100	700	1550	1250	700	2000	3050	3750	2500	1500	4250
5	340	1100	850	1550	1400	700	2000	3050	3900	2500	1500	4250
6	408	1100	1000	1550	1550	700	2000	3050	4050	2500	1500	4250
8	544	1300	1100	1750	1650	800	2000	3250	4150	2500	1500	4250
10	680	1350	1300	1850	1650	800	2000	3300	4350	2500	1500	4250

Civil dimensions for Goods Lift

Capacity		Car Inside		Lift Well		Entrance		Machine Room Size			Pit	Overhead
Load in Kg.		Width	Depth	Width	Depth	Width	Height	Width	Depth	Height		
500		1100	1200	1800	1550	1100	2000	3800	4050	2500	1500	4500
800		1100	1800	1800	2150	1100	2000	3800	4650	2500	1500	4500
1000		1400	1800	2200	2150	1400	2000	4200	4650	2500	1500	4500
1500		1700	2000	2500	2350	1700	2000	4500	4850	2500	1500	4500
2000		1700	2500	2500	2850	1700	2000	4500	5350	2500	1500	4500
2500		2000	2500	2900	2850	2000	2000	4900	5350	2500	1500	4500
3000		2000	3000	2900	3350	2000	2000	4900	5850	2500	1500	4500
4000		2500	3500	3400	3500	2500	2000	5400	5850	2500	1500	4500
5000		2500	3600	3400	3950	2500	2000	5400	6450	2500	1500	4500

Our Partners:



Angel Elevators & Escalators

Head Office : Plot No. D-107, Sector-2, Noida, Uttar Pradesh - 201301

Meeting Places : Gurugram, Delhi, Noida, Mumbai, Hyderabad, Pune

Cell : 9810 54 08 47, 7838 27 71 72, E-mail : manender.angel@gmail.com